

320D2/D2 L

Hydraulic Excavator

2017



Engine

Engine Model	Cat® C7.1	
Engine Power (ISO 14396)	112.5 kW	151 hp
Net Power (SAE J1349)	106 kW	142 hp

Weights

Minimum Operating Weight – Std. Undercarriage	21 200 kg	46,700 lb
Maximum Operating Weight – Std. Undercarriage	21 400 kg	47,200 lb
Minimum Operating Weight – Long Undercarriage	21 700 kg	47,800 lb
Maximum Operating Weight – Long Undercarriage	22 000 kg	48,500 lb

320D2/D2 L Differentiating Features

Engine

A powerful Cat C7.1 engine meets Brazil MAR-1 emission standards. Combined with a mechanical governed fuel system, the engine is well suited for local fuels in your regions.

Structures

Caterpillar design and manufacturing techniques assure you get outstanding durability and service life in the toughest applications.

Operator Station

The spacious cab features excellent visibility and easy-to-access switches. The monitor features a full-color graphical display that is user intuitive and highly visual. Overall, the new cab provides you with a comfortable working environment for maximum production and efficiency.

Reduced Service and Maintenance Cost

Routine service and maintenance can be completed quickly and easily to help you reduce ownership costs. Convenient access points, extended service intervals, and advanced filtration help keep downtime to a minimum.

Contents

Operator Station.....	4
Engine	6
Hydraulics	7
Undercarriage and Structures	8
Front Linkage	9
Cat Connect Technology.....	10
Service and Maintenance	11
Attachments.....	12
Complete Customer Support.....	14
Safety	15
Specifications.....	16
Standard Equipment.....	31
Optional Equipment.....	32
Notes.....	33





The 320D2/D2 L carries proven features and is configured for heavy construction to improve your job site efficiency through low owning and operating costs, excellent performance, and high versatility. It will deliver great fuel savings and productivity in truck loading, trenching, and lifting.

Operator Station

Enhance your comfort, operation, and visibility.
The 320D2/D2 L allows you to focus on your job.



Operator Station

The ergonomically designed operator station is spacious, quiet, and comfortable, assuring high productivity during a long work day. All switches are located in front of the operator for convenient access.

Monitor

The monitor is a full-color Liquid Crystal Display (LCD) that has the capability of displaying information in 42 languages.

Joystick Control

Low-effort pilot-operated joystick controls are designed to match your natural wrist and arm position for maximum comfort and minimum fatigue.

Seat

The mechanical suspension seat provides a variety of adjustments to accommodate a wide range of operators. All seats include a reclining back, upper and lower seat slide adjustments, and height and tilt adjustments to meet operator needs for comfort and productivity.

Console

The right and left joystick console can be adjusted to meet individual preferences, improving operator comfort and productivity during the course of a day.

Climate Control

Positive filtered ventilation with a pressurized cab is standard. Fresh air or re-circulated air can be selected with a switch on the left console.

Cab Structure and Mounts

The cab shell features a thick steel tubing. This improves resistance to fatigue and vibration. The cab is attached to the frame with viscous rubber cab mounts, which dampen vibrations and sound levels while enhancing operator comfort.

Windows

To maximize visibility, all glass is affixed directly to the cab, eliminating window frames. The upper front windshield opens, closes, and stores on the roof above the operator with a one-touch release system.

Wipers

Pillar-mounted wipers increase your operator's viewing area and offer continuous and intermittent modes.

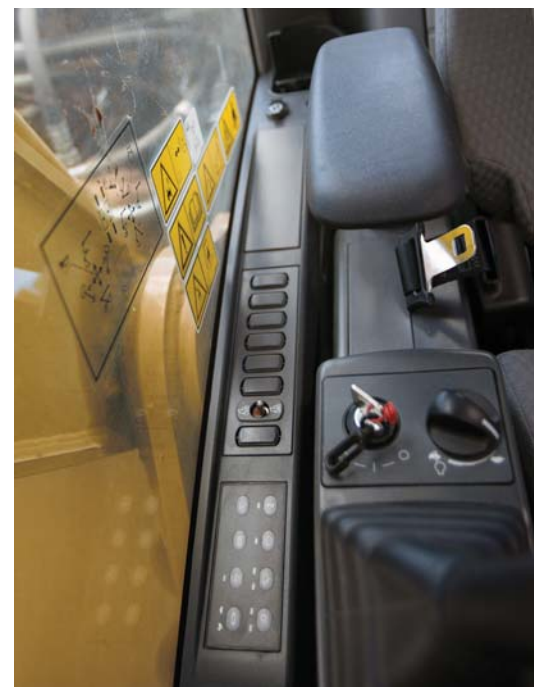

Engine

A powerful engine with excellent reliability and low fuel consumption delivering more while boosting your bottom line.

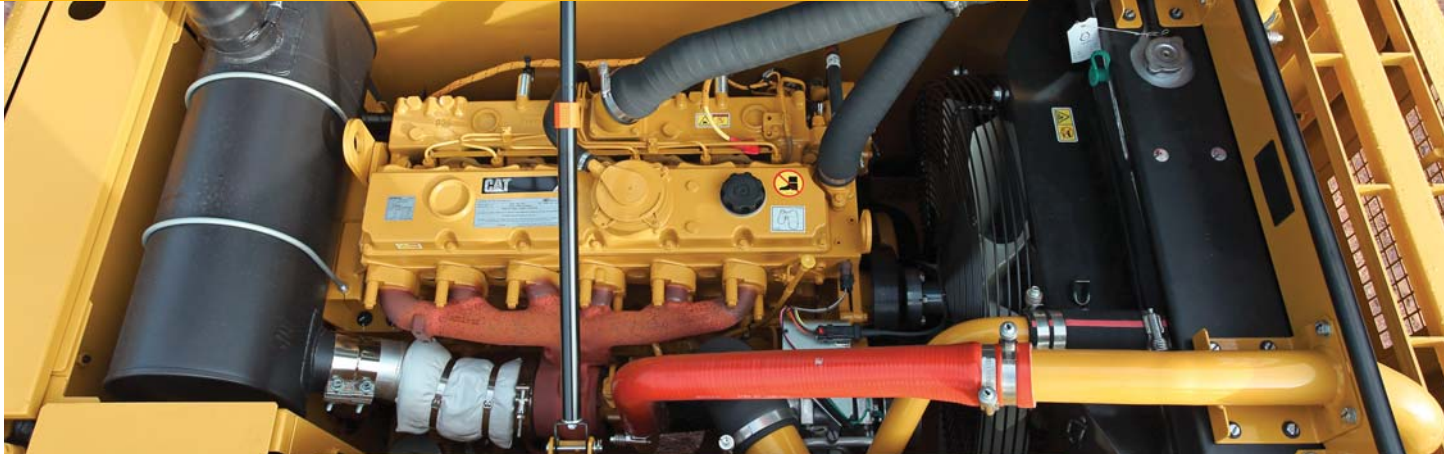

The Cat C7.1 engine meets Brazil MAR-1 emission standards with mechanical governed fuel system. The engine is powerful, strong, and durable to meet all of your application needs. An ECO-mode feature helps reduce fuel consumption by up to 15 percent for fuel-conscious customers. The C7.1 engine incorporates proven, robust components and precision manufacturing you can count on for reliable and efficient operation. This engine is less sensitive to low-quality fuel and also delivers better fuel consumption.

Air Cleaner and Air Precleaner

The radial seal air filter features a double-layered filter core for more efficient filtration and is located in a compartment behind the cab. A warning is displayed on the monitor when dust accumulates above a preset level. An air precleaner reduces the amount of dust and debris that enter the air intake system, which can help maximize engine performance by extending air filter life.

Filtration System

The C7.1 engine features an improved filtration system to ensure good reliability of fuel injection system components. Intervals have been extended and the number of filters reduced to maximize your profit potential.

Variable Speed Fan

A variable speed fan reduces fuel consumption and noise.



Electric Priming Pump

This pump reduces the risk of fuel contamination by preventing unfiltered fuel from being backfilled during filter changes.

Automatic Engine Speed Control

Automatic engine speed control is activated during no-load or light-load conditions, which reduces engine speed to minimize fuel consumption.

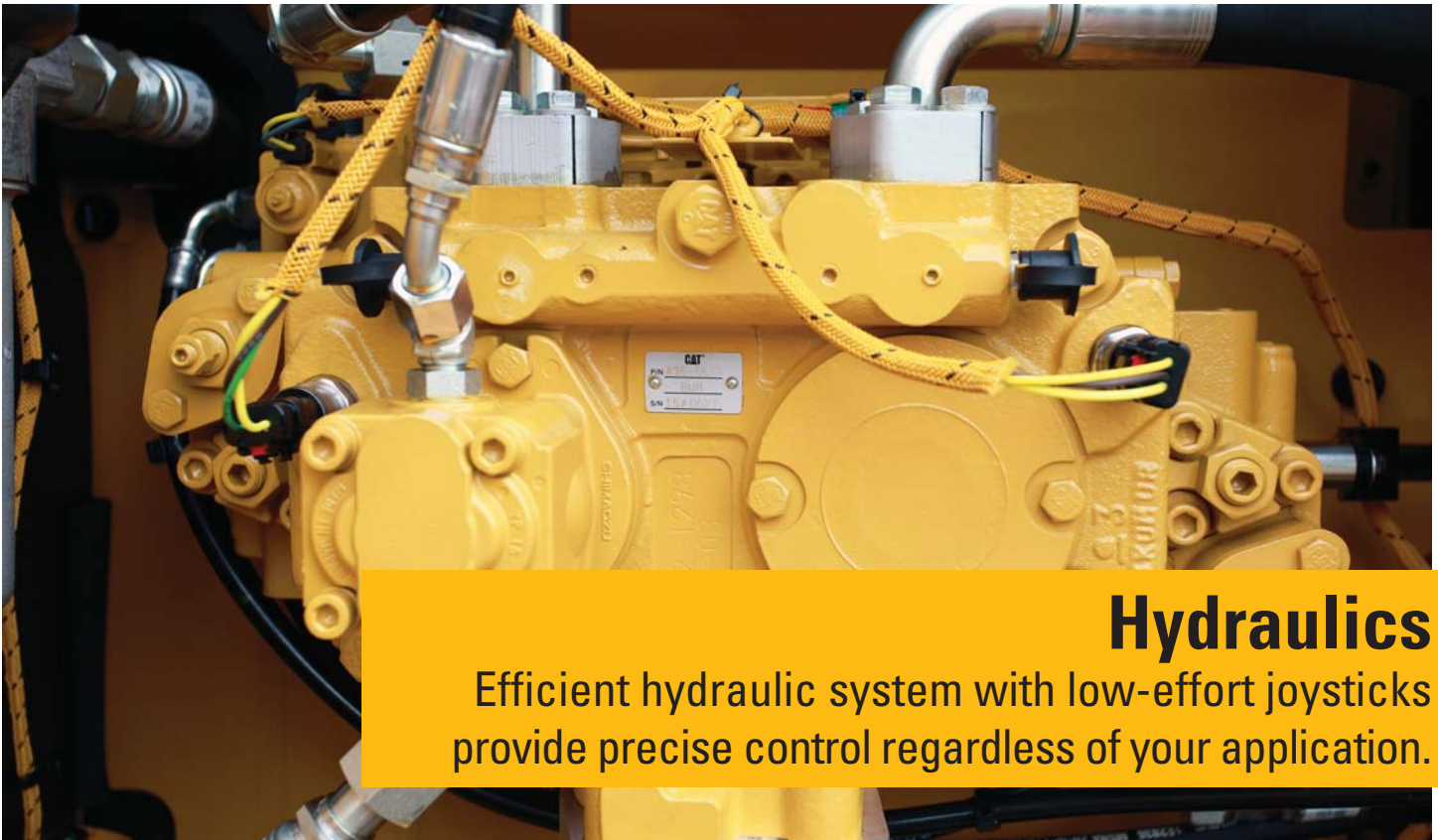

Hydraulics

Efficient hydraulic system with low-effort joysticks provide precise control regardless of your application.

Hydraulic System

Hydraulic system pressure is 35 000 kPa (5,076 psi) with 202 L/min (53.36 gal/min) flow from each of the two hydraulic pumps for increased digging performance and productivity.

Pilot System

An independent pilot pump enables smooth, precise control for the front linkage, swing, and travel operations.

Component Layout

The 320D2/D2 L hydraulic system and component locations have been designed to provide a high level of system efficiency. The main pumps, control valves, and hydraulic tank are located close together to allow for shorter tubes and lines between components, which reduce friction loss and pressure drops.

Hydraulic Cross-Sensing System

The hydraulic cross-sensing system utilizes each of two hydraulic pumps to 100 percent of engine power under all operating conditions. This improves productivity with faster implement speeds and quicker, stronger pivot turns.

Auxiliary Hydraulic Valve

Control circuits are available as attachments to improve versatility. They allow operation of high- and medium-pressure tools such as shears, grapples, hammers, pulverizers, multi-processors, and vibratory plate compactors.

Boom and Stick Regeneration Circuit

Boom and stick regeneration circuits save energy during boom-down and stick-in operation, which increases efficiency, and reduces cycle times and pressure loss for higher productivity, lower operating costs, and increased fuel efficiency.

Hydraulic Cylinder Snubbers

Snubbers are located at the rod-end of the boom cylinders and both ends of the stick cylinders to cushion shocks while reducing sound levels and extending component life.

Return Capsule Filter

The return capsule filter has a cartridge inside to avoid contamination when accessing, enabling changing without oil spillage. The filter takes out impurities and has a sensor that indicates to the operator if the filter is clogged.

Undercarriage and Structures

Strong and durable, all you expect from Cat excavators.



Carbody Design and Track Roller Frames

The X-shaped, box-section carbody provides excellent resistance to torsional bending. Robot-welded track roller frames are press-formed pentagonal units to deliver exceptional strength and service life.

Main Frame

The upper frame is designed using inverse "T" shaped beams made out of high-tensile-strength steel, providing excellent durability whatever your application. The 320D2/D2 L incorporates a one-piece upper frame table to improve strength and reliability. Both the boom tower and the main frame are constructed of solid plates, and the areas adjacent to the boom foot are reinforced, adding to overall durability.

Lower Structure

The 320D2/D2 L carbody features a box section "X" structure welded close to the ends of the track roller frame. As a result, overall rigidity and resistance to torsional rigidity between the track roller frames and the carbody are high. The standard undercarriage is well suited for applications that require frequent repositioning of the machine, restricted work space, or uneven rocky terrain. The standard undercarriage maintains great stability and lift capacity and offers a very stable work platform.

The long (L) undercarriage maximizes stability and lift capacity. This long, wide, and sturdy undercarriage offers a very stable work platform.

Rollers and Idlers

Sealed and lubricated track rollers, carrier rollers, and idlers provide excellent service life to keep your machine in the field and working longer.

Undercarriage

The 320D2/D2 L uses a grease-lubricated track link with grease being sealed between the pin and the bushing. These seals deliver longer wear life by preventing dirt and debris from entering into the space between the pin and the bushing. The master link incorporates a split type pin to help make routine service and maintenance quick and easy.

Front Linkage

Reliable, durable, and versatile to meet all your application needs.



Cat front linkages are designed for maximum versatility, productivity, and high efficiency whatever the application.

Heavy-Duty Front Linkage

The 5.7 m (18'8") heavy duty (HD) reach boom is reinforced to be used in the severest applications while providing maximum digging capability. The boom is made of high-tensile-strength steel using a large box-section design with interior baffle plates and an additional bottom guard for long life and durability.

The HD reach boom has two stick options available to meet all your application requirements. The 2.9 m (9'6") HD stick is the most versatile option and a very good fit for truck loading and trenching applications where you need additional working range. The 2.5 m (8'2") HD stick is ideally suited to applications requiring larger bucket sizes. It maximizes digging forces and enables you to get your jobs completed faster.



Cat® Connect Technology

Monitor, manage, and enhance job site operations.



Cat Connect makes smart use of technology and services to improve your job site efficiency. Using the data from technology-equipped machines, you'll get more information and insight into your equipment and operations than ever before.

Cat Connect technologies offer improvements in these key areas:



EQUIPMENT
MANAGEMENT

Equipment Management – increase uptime and reduce operating costs.



PRODUCTIVITY

Productivity – monitor production and manage job site efficiency.



SAFETY

Safety – enhance job site awareness to keep your people and equipment safe.

Service and Maintenance

Simplified service and maintenance features save you time and money.

Ground-Level Service

The design and layout of the 320D2/D2 L was made with the service technician in mind. Most service locations are easily accessible at ground level to allow service and maintenance to get completed quickly and efficiently.

Air Filter Compartment

The air filters feature a double-element construction for superior cleaning efficiency. When the air filter plugs, a warning is displayed on the cab monitor. Maintenance free batteries are standard along with a battery disconnect switch.

Pump Compartment

A service door on the right side of the upper structure allows ground-level access to the hydraulic pumps, hydraulic filters, engine oil filter, and fuel filters.

Radiator Compartment

The left rear service door allows easy access to the engine radiator, hydraulic oil cooler, air-to-air aftercooler, and AC condenser. A reserve tank and drain cock are attached to the radiator for ground level maintenance.

Greasing Points

A concentrated remote greasing block on the boom allows the greasing of hard-to-reach locations. A remote mounted greasing point on the swing bearing allows ease of service.

Diagnostics and Monitoring

The 320D2/D2 L is equipped with Scheduled Oil Sampling (S-O-SSM) ports for the hydraulic system, engine oil, and coolant. Standard hydraulic test ports enable a service technician to quickly and easily fault find in the event of service issue.



Attachments

Dig, hammer, rip, and cut with confidence.

1



Each Cat work tool is designed to optimize the versatility and performance of your machine. An extensive range of buckets, compactors, grapples, multi-processors, rippers, crushers, pulverizers, hammers, and shears is available for your 320D2/D2 L.

2



Cat General Duty Buckets (GD)

These buckets are designed for digging in low-impact, moderately abrasive materials such as dirt, loam, gravel, and clay.

Heavy Duty Buckets (HD)

HD buckets are a good starting point when application conditions vary. Especially when conditions include mixed dirt, clay, sand, and gravel.

3

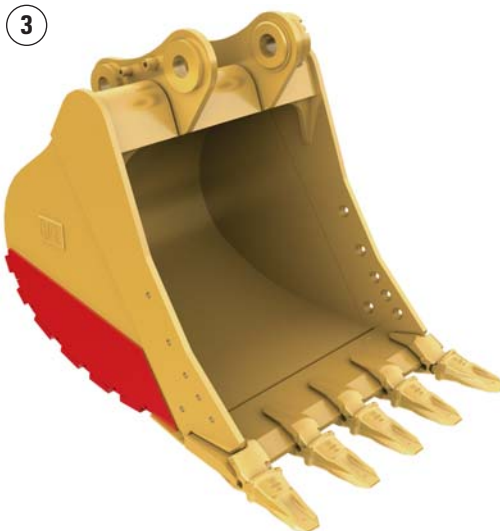

Severe Duty Buckets (SD)

These buckets are best suited to highly abrasive applications such as shot rock, sand stone, and granite.

1) Cat General Duty Buckets (GD)
2) Heavy Duty Buckets (HD)
3) Severe Duty Buckets (SD)

Couplers

Quick couplers allow one person to change work tools in seconds for maximum performance and flexibility on a job site. One machine can move rapidly from task to task, and a fleet of similarly equipped machines can share a common work tool inventory.

Cat Pin Grabber Couplers

The Cat Pin Grabber Coupler is easy to activate, easy to engage, easy to disengage. Operating procedures are simple and easy to learn. It's the easiest way to improve productivity on every job site.

One excavator can share buckets and a variety of attachments with similar size excavators. Managing your assets just got easier.

B Series Hammers

B Series hammers have outstanding field-proven reliability and durability for tough applications. It has optimized tool length and design and high grade steel and heat treatment provides high output.

E Series Hammers

E Series hammers bring together customer expectations of performance, quality, and serviceability along with Caterpillar manufacturing and logistics experience.

E Series hammers are quiet, and noise suppression is valuable in urban and restricted work areas.

Rip and Load

Ripping can greatly improve your quarry margins. Drilling and blasting costs can be significantly reduced or eliminated. Using the same excavator to load trucks as well as rip can cut loading costs. Ripping allows more selective rock extraction, resulting in better quality product for the crusher, with lower crushing and processing costs.

Grapples

Cat grapples replace the bucket on Cat excavators, converting them to the ideal machine for handling loose material, sorting trash, and demolition site cleanup. An array of styles and sizes are available to match excavators to the task at hand.

Multi-Processors

Multi-processors do the work of many types of demolition tools by use of interchangeable jaw sets. Changing jaws allows a single unit to crush, pulverize, and perform a variety of specialized cutting tasks such as cutting steel rebar and tanks.

Shear

Cat shears are designed for Cat machines – taking full advantage of the hydraulic flows and pressures to enhance productivity without compromising safety or causing premature wear of the shear and carrier.

Pulverizer

The excavator mounted mechanical pulverizer is a cost-effective tool for recycling demolished concrete debris. The bucket cylinder on the excavator powers the mechanical pulverizer. This eliminates the need for a dedicated cylinder and associated hydraulics and additional installation cost.

Vibratory Plate Compactor

Compactors enhance the versatility of your excavator and makes compacting faster, more efficient, and cost-effective. Cat compactors are the superior choice for any job site's compaction tasks.

Crusher

The hydraulic concrete crusher has taken modern demolition technology a step further. It is well suited for concrete demolition in residential areas. The hydraulic concrete crusher combines several concrete demolition operations in one piece of equipment:

- breaking out concrete from fixed structures
- pulverizing concrete
- cutting reinforcement rods and small steel profiles



Complete Customer Support

Cat dealer services offer a wide range of personalized solutions.



Product Support

Cat dealers utilize a worldwide computer network to find in-stock parts to minimize machine downtime. You can also save money with our line of remanufactured components.

Machine Selection

Your Cat dealers can provide specific recommendations with detailed comparisons of the Cat machines you are considering before you buy. This ensures you get the right size machine and appropriate work tools to meet all of your application needs.

Maintenance Services

Repair option programs guarantee the cost of repairs up front. Condition monitoring services and diagnostic programs such as scheduled oil sampling, coolant sampling, and technical analysis help you avoid unscheduled repairs.

Customer Support Agreements

Cat dealers offer a variety of product support agreements which can be tailored to meet your specific needs. These plans can cover the entire machine – including attachments – to help protect your investment.

Replacement

Repair, rebuild, or replace? Your Cat dealers can help you evaluate the costs involved so you can make the right choice.

Safety

Features to help protect you day in and day out.

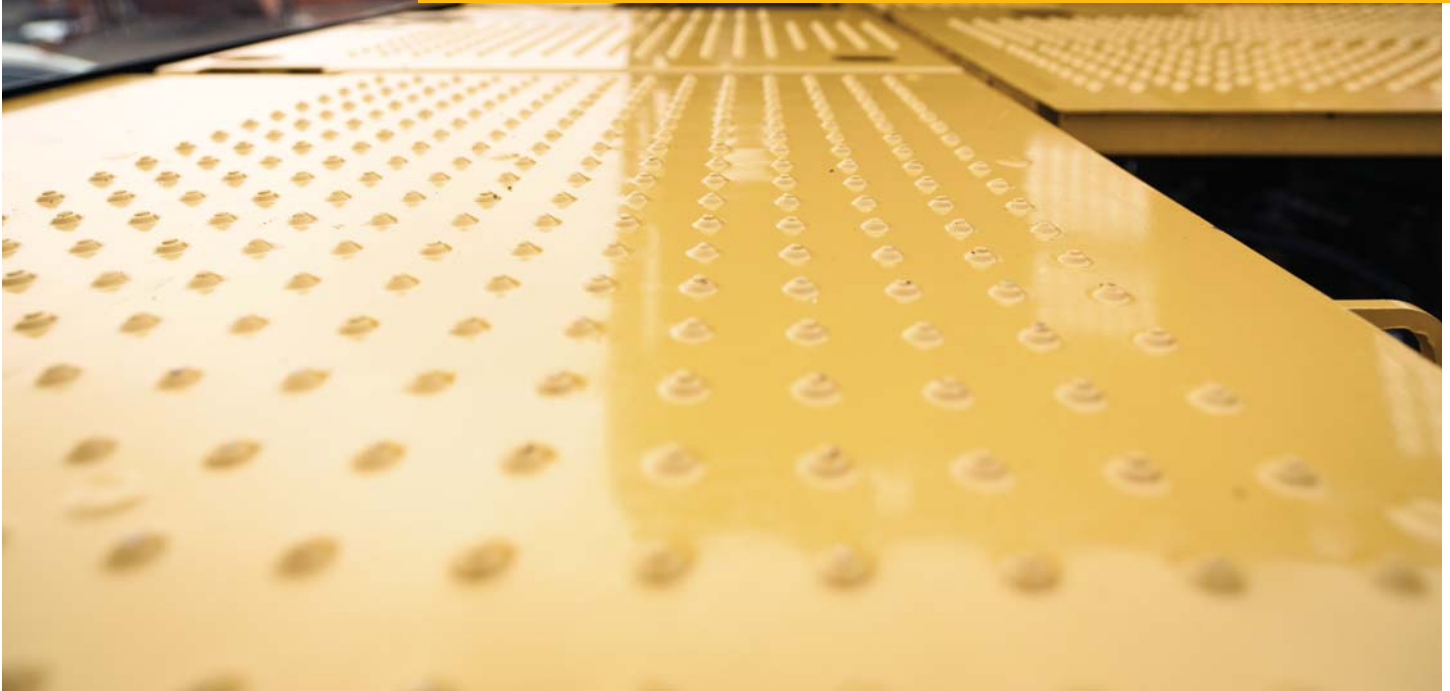

Anti-skid plating with countersunk bolts reduces the potential for slippage and trip hazards, providing a **safe platform** for all routine service and maintenance needs.

The standard **hydraulic lockout lever** isolates all hydraulic and travel functions in the lowered position. It is specifically designed to not allow the operator to leave the cab without first lowering it.



Three circuit breakers protect critical electrical components to increase machine uptime.

A **battery disconnect switch** helps to deter theft by isolating the battery and enhances safety when servicing the machine.

A full length **firewall** separates the engine from the hydraulic pump and offers protection in the event of an incident.

Ground level **shut-off switch** stops all fuel to the engine when activated and shuts down the machine.



Fan Guard

The engine radiator fan is enclosed by a steel guard that provides maximum protection when carrying out routine service and maintenance.

320D2/D2 L Hydraulic Excavator Specifications

Engine

Engine Model	Cat C7.1	
Engine Power – ISO 14396	112.5 kW	151 hp
Net Power – SAE J1349	106 kW	142 hp
Engine RPM		
Operation	1,700 rpm	
Travel	1,800 rpm	
Bore	105 mm	4.13 in
Stroke	135 mm	5.31 in
Displacement	7.01 m ³	428 in ³

- The 320D2/D2 L meets Brazil MAR-1 emission standards.
- Net power advertised is the power available at the flywheel when the engine is equipped with fan, air cleaner, muffler and alternator.
- The altitude capability (without aid) of 320D2/D2 L is up to 4000 m (13,120 ft) with natural power de-rate above sea level.
- Power Rating at 1,800 rpm.

Weights

Standard Undercarriage:		
Minimum Operating Weight*	21 200 kg	46,700 lb
Maximum Operating Weight**	21 400 kg	47,200 lb
Long Undercarriage:		
Minimum Operating Weight*	21 700 kg	47,800 lb
Maximum Operating Weight**	22 000 kg	48,500 lb

*R5.7 m (18'8") HD Reach boom, R2.5 m (8'2") B1 HD Reach stick, HD 1.00 m³ (1.3 yd³) bucket and 600 mm (24") triple grouser shoes.

**R5.7 m (18'8") HD Reach boom, R2.9 m (9'6") B1 HD Reach stick, HD 1.00 m³ (1.3 yd³) bucket and 700 mm (28") triple grouser shoes.

Track

Standard Undercarriage:		
Number of Shoes Each Side	45 pieces	
Number of Track Rollers Each Side	7 pieces	
Number of Carrier Rollers Each Side	2 pieces	
Long Undercarriage:		
Number of Shoes Each Side	49 pieces	
Number of Track Rollers Each Side	8 pieces	
Number of Carrier Rollers Each Side	2 pieces	

Swing Mechanism

Swing Speed	10.9 rpm	
Maximum Swing Torque	72 kN·m	52,367 lbf·ft

Drive

Maximum Gradeability	35°/70%	
Maximum Travel Speed – High	5.4 km/h	3.4 mph
Maximum Drawbar Pull	205 kN	46,086 lb

Hydraulic System

Main System – Maximum Flow (Total)	404 L/min	106.7 gal/min
Maximum Pressure – Equipment	35 MPa	5,076 psi
Maximum Pressure – Travel	35 MPa	5,076 psi
Maximum Pressure – Swing	25 MPa	3,626 psi
Pilot System – Maximum Flow (Total)	32.4 L/min	8.6 gal/min
Pilot System – Maximum Pressure	3900 kPa	566 psi
Boom Cylinder – Bore	120 mm	4.7 in
Boom Cylinder – Stroke	1260 mm	49.6 in
Stick Cylinder – Bore	140 mm	5.5 in
Stick Cylinder – Stroke	1504 mm	59.2 in
Bucket Cylinder – Bore	120 mm	4.7 in
Bucket Cylinder – Stroke	1104 mm	43.5 in

Service Refill Capacities

Fuel Tank Capacity	410 L	108.3 gal
Cooling System	25 L	6.6 gal
Engine Oil	22 L	5.8 gal
Swing Drive	8 L	2.1 gal
Final Drive	8 L	2.1 gal
Hydraulic System (including tank)	260 L	68.7 gal
Hydraulic Tank	138 L	36.5 gal

Sound Performance

ISO 6395 (external)	102 dB(A)
ISO 6396 (inside cab)	72 dB(A)

- When properly installed and maintained, the cab offered by Caterpillar, when tested with doors and windows closed according to ANSI/SAE J1166 OCT98, meets the requirements for operator sound exposure limits in effect at time of manufacture.
- Hearing protection may be needed when operating with an open operator station and cab (when not properly maintained or doors/windows open) for extended periods or in a noisy environment.

Standards

Brakes	ISO 10265:2008
Cab/FOGS	SAE J1356 MAR2013 ISO 10262:1998

320D2/D2 L Hydraulic Excavator Specifications

Dimensions

All dimensions are approximate.

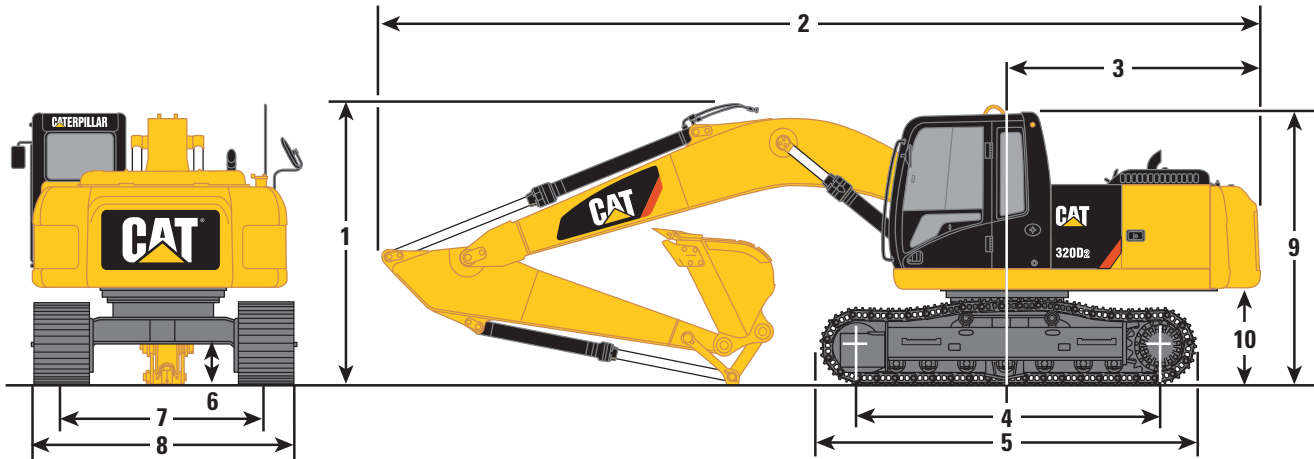

Boom Options

HD Reach Boom 5.7 m (18'8")*

Stick Options

HD R2.9 m (9'6") B1

HD R2.5 m (8'2") B1

	HD R2.9 m (9'6") B1		HD R2.5 m (8'2") B1	
1 Shipping Height**	3030 mm	9'11"	3050 mm	10'0"
2 Shipping Length	9460 mm	31'0"	9460 mm	31'0"
3 Tail Swing Radius	2750 mm	9'0"	2750 mm	9'0"
4 Length to Center of Rollers				
Standard Undercarriage	3270 mm	10'9"	3270 mm	10'9"
Long Undercarriage	3650 mm	12'0"	3650 mm	12'0"
5 Track Length				
Standard Undercarriage	4080 mm	13'5"	4080 mm	13'5"
Long Undercarriage	4460 mm	14'8"	4460 mm	14'8"
6 Ground Clearance***	450 mm	1'6"	450 mm	1'6"
7 Track Gauge				
Standard Undercarriage	2200 mm	7'3"	2200 mm	7'3"
Long Undercarriage	2380 mm	7'10"	2380 mm	7'10"
8 Transport Width – Standard Undercarriage				
600 mm (24") Shoes	2800 mm	9'2"	2800 mm	9'2"
700 mm (28") Shoes	2900 mm	9'6"	2900 mm	9'6"
Transport Width – Long Undercarriage				
600 mm (24") Shoes	2980 mm	9'9"	2980 mm	9'9"
700 mm (28") Shoes	3080 mm	10'1"	3080 mm	10'1"
9 Cab Height***	2950 mm	9'8"	2950 mm	9'8"
10 Counterweight Clearance***	1020 mm	3'4"	1020 mm	3'4"

*With HD 1.00 m³ (1.3 yd³) Bucket.

**Including shoe lug height.

***Without shoe lug height.

320D2/D2 L Hydraulic Excavator Specifications

Working Ranges

All dimensions are approximate.

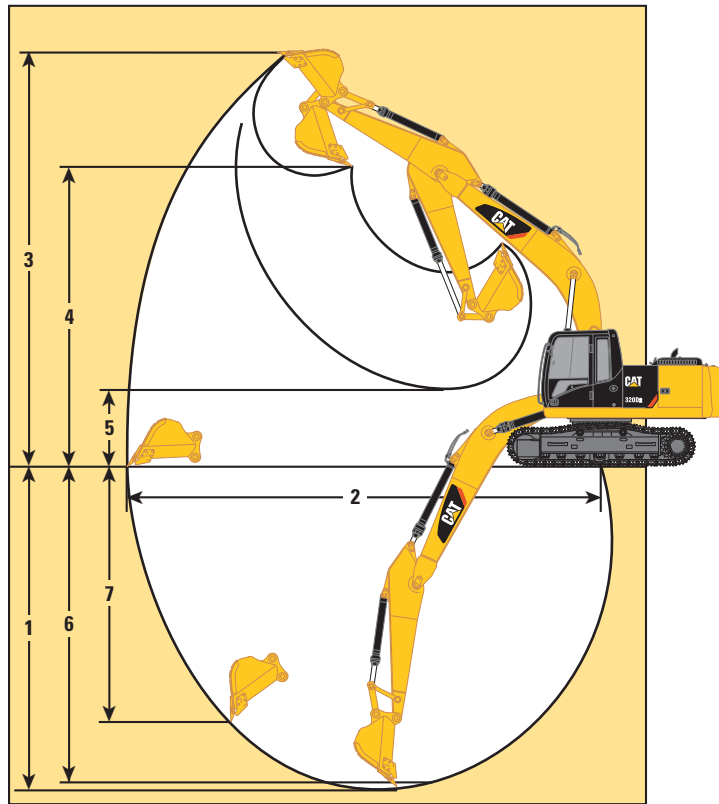

Boom Options

HD Reach Boom 5.7 m (18'8")

Stick Options

HD R2.9 m (9'6") B1

HD R2.5 m (8'2") B1

Bucket Type/Capacity	HD 1.0 m ³	HD 1.3 yd ³	HD 1.0 m ³	HD 1.3 yd ³
1 Maximum Digging Depth	6720 mm	22'1"	6300 mm	20'8"
2 Maximum Reach at Ground Line	9890 mm	32'5"	9470 mm	31'1"
3 Maximum Cutting Height	9490 mm	31'2"	9250 mm	30'4"
4 Maximum Loading Height	6490 mm	21'4"	6290 mm	20'8"
5 Minimum Loading Height	2170 mm	7'1"	2590 mm	8'6"
6 Maximum Depth Cut for 2240 mm (8 ft) Level Bottom	6380 mm	20'11"	5960 mm	19'7"
7 Maximum Vertical Wall Digging Depth	5690 mm	18'8"	5290 mm	17'4"
Bucket Digging Force (SAE)	125 kN	28,100 lbf	125 kN	28,100 lbf
Bucket Digging Force (ISO)	140 kN	31,500 lbf	140 kN	31,500 lbf
Stick Digging Force (SAE)	104 kN	23,300 lbf	114 kN	25,700 lbf
Stick Digging Force (ISO)	107 kN	24,000 lbf	118 kN	26,600 lbf

320D2/D2 L Hydraulic Excavator Specifications

Operating Weight and Ground Pressure

	600 mm (24") Triple Grouser Shoes				700 mm (28") Triple Grouser Shoes				600 mm (24") Double Grouser Shoes			
	Weight		Ground Pressure		Weight		Ground Pressure		Weight		Ground Pressure	
	kg	lb	kPa	psi	kg	lb	kPa	psi	kg	lb	kPa	psi
Standard Undercarriage												
HD Reach Boom – 5.7 m (18'8"), HD 1.0 m ³ (1.3 yd ³) Bucket												
HD R2.9 (9'6") Stick	21 100	46,500	48.6	7.0	21 400	47,200	42.2	6.1	21 300	47,000	49.0	7.1
HD R2.5 (8'2") Stick	21 100	46,500	48.6	7.0	21 400	47,200	42.2	6.1	21 300	47,000	49.0	7.1
Long Undercarriage												
HD Reach Boom – 5.7 m (18'8"), HD 1.0 m ³ (1.3 yd ³) Bucket												
HD R2.9 (9'6") Stick	21 600	47,600	44.9	6.5	22 000	48,500	39.2	5.7	21 900	48,300	45.5	6.6
HD R2.5 (8'2") Stick	21 600	47,600	44.9	6.5	22 000	48,500	39.2	5.7	21 900	48,300	45.5	6.6

320D2/D2 L Hydraulic Excavator Specifications

Major Component Weights

Base Machine (including boom cylinders, pins, fluids, operator)	6640 kg	14,640 lb
Undercarriage		
Standard Undercarriage	4180 kg	9,220 lb
Long Undercarriage	4490 kg	9,900 lb
Counterweight	3700 kg	8,160 lb
Boom (including lines, pins and stick cylinder)		
HD Reach Boom – 5.7 m (18'8")	2020 kg	4,450 lb
Stick (including lines, pins, bucket cylinder and bucket linkage)		
HD R2.9 (9'6") B1 Stick	1110 kg	2,450 lb
HD R2.5 (8'2") B1 Stick	1080 kg	2,380 lb
Track Shoe (standard/per two track)		
600 mm (24") Triple Grouser Shoes	2480 kg	5,470 lb
700 mm (28") Triple Grouser Shoes	2820 kg	6,220 lb
600 mm (24") Double Grouser Shoes	2710 kg	5,980 lb
Track Shoe (long/per two track)		
600 mm (24") Triple Grouser Shoes	2700 kg	5,950 lb
700 mm (28") Triple Grouser Shoes	3070 kg	6,770 lb
600 mm (24") Double Grouser Shoes	2950 kg	6,500 lb
GD 1.0 m ³ (1.3 yd ³) Bucket with Sidecutter and Tip	760 kg	1,680 lb
HD 1.0 m ³ (1.3 yd ³) Bucket with Sidecutter and Tip	970 kg	2,140 lb
HD 1.19 m ³ (1.56 yd ³) Bucket with Sidecutter and Tip	1000 kg	2,210 lb

Note: Kg and lb were rounded up separately so some of the kg and lb do not match.

ISO 6016 Operating Weight Criteria: Base Machine with fronts, bucket, full fuel tank (and fluids), 75 kg (165 lb) operator. This standard excludes optional attachments.

320D2/D2 L Hydraulic Excavator Specifications

Bucket Specifications and Compatibility

	Linkage	Width		Capacity		Weight		Fill	HD Reach Boom – 5.7 m (18'8")												
									HD R2.5 m (8'2") B1						HD R2.9 m (9'6") B1						
									600 mm (24") Track Shoes		700 mm (28") Track Shoes		790 mm (31") Track Shoes		600 mm (24") Track Shoes		700 mm (28") Track Shoes		790 mm (31") Track Shoes		
									Undercarriage		Undercarriage		Undercarriage		Undercarriage		Undercarriage		Undercarriage		
		mm	in	m ³	yd ³	kg	lb	%	Std.	Long	Std.	Long	Std.	Long	Std.	Long	Std.	Long	Std.	Long	
Without Quick Coupler																					
Cat General Duty (GDC)	B	600	24	0.55	0.72	619	1,363	100	●	●	●	●	●	●	●	●	●	●	●	●	●
	B	750	30	0.75	0.98	710	1,566	100	●	●	●	●	●	●	●	●	●	●	●	●	●
	B	900	36	0.95	1.24	787	1,735	100	⊙	●	⊙	●	●	●	⊖	●	⊙	●	⊙	●	●
	B	1050	42	1.16	1.52	848	1,870	100	⊖	⊙	⊖	⊙	⊖	⊙	○	⊖	○	⊖	○	⊖	○
	B	1200	48	1.38	1.80	926	2,041	100	○	⊖	○	⊖	○	⊖	◇	○	◇	○	◇	○	◇
	B	1350	54	1.59	2.08	1004	2,213	100	◇	○	◇	○	◇	○	◇	◇	◇	◇	◇	◇	◇
Cat General Duty – CCL	B	1150	46	0.90	1.18	719	1,585	100	●	●	●	●	●	●	⊙	●	⊙	●	⊙	●	●
	B	1250	50	1.00	1.31	751	1,656	100	⊙	●	⊙	●	⊙	●	⊖	●	⊖	●	⊙	●	●
	B	1150	46	0.90	1.18	762	1,680	100	●	●	●	●	●	●	⊙	●	⊙	●	⊙	●	●
	B	1250	50	1.00	1.31	797	1,756	100	⊙	●	⊙	●	⊙	●	⊖	⊙	⊖	●	⊖	●	●
	B	1400	56	1.14	1.49	863	1,902	100	⊖	⊙	⊖	⊙	⊖	⊙	○	⊖	○	⊙	○	⊖	○
Heavy Duty (HD)	B	600	24	0.46	0.61	649	1,431	100	●	●	●	●	●	●	●	●	●	●	●	●	●
	B	750	30	0.64	0.84	748	1,649	100	●	●	●	●	●	●	●	●	●	●	●	●	●
	B	900	36	0.81	1.06	826	1,821	100	●	●	●	●	●	●	⊙	●	●	●	●	●	●
	B	1050	42	1.00	1.31	880	1,940	100	⊙	●	⊙	●	⊙	●	⊖	⊙	⊖	●	⊙	⊖	○
	B	1200	48	1.19	1.56	907	1,999	100	⊖	⊙	⊖	⊙	⊖	⊙	○	⊖	○	⊖	○	⊖	○
	B	1200	48	1.19	1.56	918	2,024	100	⊖	⊙	⊖	⊙	⊖	⊙	○	⊖	○	⊖	○	⊖	○
	B	1200	48	1.19	1.56	972	2,141	100	○	⊖	○	⊖	○	⊖	○	⊖	○	⊖	○	⊖	○
	B	1300	52	1.30	1.71	962	2,120	100	○	⊖	○	⊖	○	⊖	◇	○	◇	○	◇	○	◇
	B	1350	54	1.38	1.81	1054	2,322	100	◇	○	◇	○	◇	○	◇	◇	◇	◇	◇	◇	◇
	B	1350	54	1.40	1.83	1012	2,230	100	○	○	○	○	○	⊖	○	◇	○	◇	○	◇	○
	Severe Duty (SD)	B	600	24	0.46	0.61	694	1,530	90	●	●	●	●	●	●	●	●	●	●	●	●
B		750	30	0.64	0.84	802	1,768	90	●	●	●	●	●	●	●	●	●	●	●	●	●
B		900	36	0.81	1.06	889	1,959	90	●	●	●	●	●	●	●	●	●	●	●	●	●
B		1050	42	1.00	1.31	964	2,125	90	⊙	●	⊙	●	⊙	●	⊖	⊙	⊖	●	⊖	●	●
B		1200	48	1.19	1.56	1053	2,320	90	⊖	⊙	⊖	⊙	⊖	⊙	○	⊖	○	⊖	○	⊖	○
B		1200	48	1.19	1.56	1001	2,207	90	⊖	⊙	⊖	⊙	⊖	⊙	○	⊖	○	⊖	○	⊖	○
Maximum load pin-on (payload + bucket)									kg	2625	2990	2675	3050	2710	3090	2405	2755	2450	2815	2485	2850
									lb	5,786	6,590	5,896	6,722	5,973	6,810	5,301	6,072	5,400	6,204	5,477	6,281

The above loads are in compliance with hydraulic excavator standard EN474, they do not exceed 87% of hydraulic lifting capacity or 75% of tipping capacity with front linkage fully extended at ground line with bucket curled.

Capacity based on ISO 7451.

Bucket weight with Cat General Duty tips.

Maximum Material Density:

- 2100 kg/m³ (3,500 lb/yd³)
- ⊙ 1800 kg/m³ (3,000 lb/yd³)
- ⊖ 1500 kg/m³ (2,500 lb/yd³)
- 1200 kg/m³ (2,000 lb/yd³)
- ◇ 900 kg/m³ (1,500 lb/yd³)

Caterpillar recommends using appropriate work tools to maximize the value customers receive from our products. Use of work tools, including buckets, which are outside of Caterpillar's recommendations or specifications for weight, dimensions, flows, pressures, etc. may result in less-than-optimal performance, including but not limited to reductions in production, stability, reliability, and component durability. Improper use of a work tool resulting in sweeping, prying, twisting and/or catching of heavy loads will reduce the life of the boom and stick.

320D2/D2 L Hydraulic Excavator Specifications

Bucket Specifications and Compatibility

	Linkage	Width		Capacity		Weight		Fill	HD Reach Boom – 5.7 m (18'8")											
									HD R2.5 m (8'2") B1						HD R2.9 m (9'6") B1					
									600 mm (24") Track Shoes		700 mm (28") Track Shoes		790 mm (31") Track Shoes		600 mm (24") Track Shoes		700 mm (28") Track Shoes		790 mm (31") Track Shoes	
									Undercarriage		Undercarriage		Undercarriage		Undercarriage		Undercarriage		Undercarriage	
	mm	in	m ³	yd ³	kg	lb	%	Std.	Long	Std.	Long	Std.	Long	Std.	Long	Std.	Long	Std.	Long	
Without Pin Grabber Coupler																				
Cat General Duty (GDC)	B	600	24	0.55	0.72	619	1,363	100	●	●	●	●	●	●	●	●	●	●	●	●
	B	750	30	0.75	0.98	710	1,566	100	●	●	●	●	●	⊙	●	⊙	●	⊙	●	●
	B	900	36	0.95	1.24	787	1,735	100	⊖	⊙	⊖	⊙	⊖	⊙	○	⊖	○	⊖	○	⊙
	B	1050	42	1.16	1.52	848	1,870	100	○	⊖	○	⊖	○	⊖	◇	○	◇	○	◇	○
	B	1200	48	1.38	1.80	926	2,041	100	◇	○	◇	○	◇	○	X	◇	X	◇	X	◇
	B	1350	54	1.59	2.08	1004	2,213	100	X	◇	X	◇	X	◇	X	X	X	◇	X	◇
Heavy Duty (HD)	B	600	24	0.46	0.61	649	1,431	100	●	●	●	●	●	●	●	●	●	●	●	●
	B	750	30	0.64	0.84	748	1,649	100	●	●	●	●	●	⊙	●	●	●	●	●	●
	B	900	36	0.81	1.06	826	1,821	100	⊖	●	⊙	●	⊙	●	⊖	⊙	⊖	⊙	⊖	⊙
	B	1050	42	1.00	1.31	880	1,940	100	○	⊖	○	⊙	○	⊙	◇	⊖	○	⊖	○	⊖
	B	1200	48	1.19	1.56	907	1,999	100	◇	○	○	⊖	○	⊖	◇	○	◇	○	◇	○
	B	1200	48	1.19	1.56	918	2,024	100	◇	○	◇	⊖	○	⊖	◇	○	◇	○	◇	○
	B	1200	48	1.19	1.56	972	2,141	100	◇	○	◇	○	◇	⊖	◇	○	◇	○	◇	○
	B	1300	52	1.30	1.71	962	2,120	100	◇	○	◇	○	◇	○	X	◇	X	◇	X	◇
	B	1350	54	1.38	1.81	1054	2,322	100	X	◇	◇	○	◇	○	X	◇	X	◇	X	◇
	B	1350	54	1.40	1.83	1012	2,230	100	◇	◇	◇	○	◇	○	X	◇	X	◇	X	◇
Severe Duty (SD)	B	600	24	0.46	0.61	694	1,530	90	●	●	●	●	●	●	●	●	●	●	●	●
	B	750	30	0.64	0.84	802	1,768	90	●	●	●	●	●	●	●	●	●	●	●	●
	B	900	36	0.81	1.06	889	1,959	90	⊙	●	⊙	●	⊙	●	⊖	⊙	⊖	●	⊖	●
	B	1050	42	1.00	1.31	964	2,125	90	○	⊙	⊖	⊙	⊖	⊙	○	⊖	○	⊖	○	⊖
	B	1200	48	1.19	1.56	1053	2,320	90	◇	○	◇	⊖	○	⊖	◇	○	◇	○	◇	○
	B	1200	48	1.19	1.56	1001	2,207	90	◇	⊖	○	⊖	○	⊖	◇	○	◇	○	◇	○
Maximum load with coupler (payload + bucket)								kg	2215	2580	2265	2640	2300	2680	1995	2345	2040	2405	2075	2440
								lb	4,883	5,687	4,993	5,819	5,070	5,907	4,398	5,169	4,497	5,301	4,574	5,378

The above loads are in compliance with hydraulic excavator standard EN474, they do not exceed 87% of hydraulic lifting capacity or 75% of tipping capacity with front linkage fully extended at ground line with bucket curled.

Capacity based on ISO 7451.

Bucket weight with Cat General Duty tips.

Maximum Material Density:

- 2100 kg/m³ (3,500 lb/yd³)
- ⊙ 1800 kg/m³ (3,000 lb/yd³)
- ⊖ 1500 kg/m³ (2,500 lb/yd³)
- 1200 kg/m³ (2,000 lb/yd³)
- ◇ 900 kg/m³ (1,500 lb/yd³)
- X Not recommended

Caterpillar recommends using appropriate work tools to maximize the value customers receive from our products. Use of work tools, including buckets, which are outside of Caterpillar's recommendations or specifications for weight, dimensions, flows, pressures, etc. may result in less-than-optimal performance, including but not limited to reductions in production, stability, reliability, and component durability. Improper use of a work tool resulting in sweeping, prying, twisting and/or catching of heavy loads will reduce the life of the boom and stick.

320D2/D2 L Hydraulic Excavator Specifications

Attachments Offering Guide

Boom Type	HD Reach		HD Reach	
	HD R2.5 m (8'2")	HD R2.9 m (9'6")	HD R2.5 m (8'2")	HD R2.9 m (9'6")
Stick Size	Standard		Long	
Undercarriage	Standard		Long	
Hydraulic Hammer	B20 H115E s H120E s H130E s^^	B20^^ H115E s H120E s H130E s^	B20 H115E s H120E s H130E s	B20 H115E s H120E s H130E s
Multi-Processor	MP318 CC Jaw^ MP318 D Jaw^ MP318 P Jaw*** MP318 S Jaw** MP318 U Jaw^	MP318 CC Jaw*** MP318 D Jaw*** MP318 P Jaw*** # MP318 S Jaw^ MP318 U Jaw*** #	MP318 CC Jaw MP318 D Jaw MP318 P Jaw^^ MP318 S Jaw MP318 U Jaw^^	MP318 CC Jaw** MP318 D Jaw** MP318 P Jaw^ MP318 S Jaw^ MP318 U Jaw**
Pulverizer	P215^^	P215**	P215	P215
Crusher	P315^	P315***	P315	P315**
Demolition and Sorting Grapple	G315B-D/R^ G315B-D/R fixed CAN	G315B-D/R*** G315B-D/R fixed CAN	G315B-D/R G315B-D/R fixed CAN	G315B-D/R** G315B-D/R fixed CAN
Scrap and Demolition Shear	S320B*** S325B##	S320B*** # S325B##	S320B^^ S325B##	S320B*** S325B##
Compactor (Vibratory Plate)	CVP110	CVP110	CVP110	CVP110
Contractors' Grapple	G120B – G130B	G120B – G130B	G120B – G130B	G120B – G130B
Orange Peel Grapple				
Clamshell Grapple				
Rippers				
Pin Grabber Coupler	Cat PG			
Dedicated Quick Coupler	CW-40 CW-40s			

These work tools are available for the 320D2/D2 L.
Consult your Cat dealer for proper match.

* Offerings not available in all areas. Matches are dependent on excavator configurations. Consult your Cat dealer to determine what is offered in your area and for proper work tool match.

** Pin-on or CW

*** Pin-on only

Work over the front only

Boom Mount

^ Work over the front only with CW (Pin-on and CW)

^^ Work over the front only with Cat PG (Pin-on, CW and Cat PG)

Note: Demolition and Sorting Grapple: D-Demolition shells, R-Recycling shells
fixed CAN – fixed hinge plates for CW quick coupler usage

320D2/D2 L Hydraulic Excavator Specifications

HD Reach Boom Lift Capacities – with Bucket Linkages, without Bucket – Standard Undercarriage

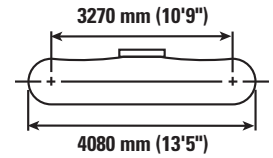
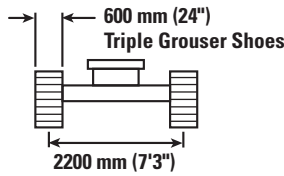
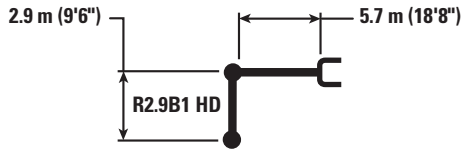

		1.5 m/5.0 ft		3.0 m/10.0 ft		4.5 m/15.0 ft		6.0 m/20.0 ft		7.5 m/25.0 ft		mm in		
7.5 m 25.0 ft	kg lb							*4500	*4500			*3850 *8,600	*3850 *8,600	6150 240
6.0 m 20.0 ft	kg lb							*4800 *10,550	4600 9,900			*3600 *7,900	3300 7,300	7290 290
4.5 m 15.0 ft	kg lb							*5300 *11,500	4450 9,550	4600 9,800	3100 6,600	*3500 *7,700	2750 6,100	7990 320
3.0 m 10.0 ft	kg lb					*7750 *16,650	6400 13,800	*6050 *13,150	4200 9,000	4450 9,600	2950 6,350	*3600 *7,900	2500 5,450	8360 330
1.5 m 5.0 ft	kg lb					*9350 20,100	5850 12,600	6050 12,950	3900 8,450	4350 9,300	2850 6,100	3600 7,950	2350 5,200	8450 340
0.0 m 0.0 ft	kg lb			*6200 *14,200	*6200 *14,200	9000 19,350	5550 11,900	5800 12,500	3750 8,050	4200 9,100	2750 5,900	3700 8,100	2400 5,250	8260 330
-1.5 m -5.0 ft	kg lb	*6600 *14,750	*6600 *14,750	*10 700 *24,300	10 300 22,100	8900 19,100	5450 11,700	5750 12,300	3650 7,850	4200 9,000	2700 5,850	4000 8,800	2600 5,700	7780 310
-3.0 m -10.0 ft	kg lb	*11 350 *25,500	*11 350 *25,500	*13 700 *29,600	10 500 22,550	8950 19,250	5500 11,850	5750 12,400	3700 7,950			4700 10,450	3050 6,800	6950 280
-4.5 m -15.0 ft	kg lb			*10 850 *23,250	*10 850 *23,250	*7800 *16,600	5750 12,350					*5900 *12,900	4250 9,600	5600 220



ISO 10567



*Indicates that the load is limited by hydraulic lifting capacity rather than tipping load. The above loads are in compliance with hydraulic excavator lift capacity standard ISO 10567:2007. They do not exceed 87% of hydraulic lifting capacity or 75% of tipping load. Weight of all lifting accessories must be deducted from the above lifting capacities. Lifting capacities are based on the machine standing on a firm, uniform supporting surface. The use of a work tool attachment point to handle/lift objects, could affect the machine lift performance.

Lift capacity stays with ±5% for all available track shoes.

Always refer to the appropriate Operation and Maintenance Manual for specific product information.

320D2/D2 L Hydraulic Excavator Specifications

HD Reach Boom Lift Capacities – with Bucket Linkages, without Bucket – Standard Undercarriage

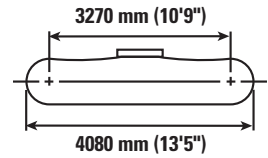
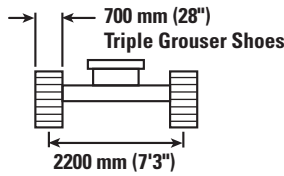
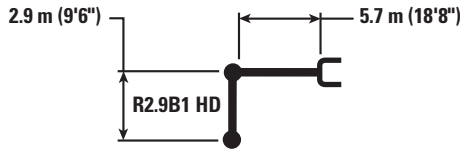

		1.5 m/5.0 ft		3.0 m/10.0 ft		4.5 m/15.0 ft		6.0 m/20.0 ft		7.5 m/25.0 ft		mm in		
7.5 m 25.0 ft	kg lb							*4500	*4500			*3850 *8,600	*3850 *8,600	6150 240
6.0 m 20.0 ft	kg lb							*4800 *10,550	4700 10,050			*3600 *7,900	3350 7,400	7290 290
4.5 m 15.0 ft	kg lb							*5300 *11,500	4500 9,700	4650 10,000	3150 6,700	*3500 *7,700	2800 6,200	7990 320
3.0 m 10.0 ft	kg lb					*7750 *16,650	6500 14,000	*6050 *13,150	4250 9,150	4550 9,750	3000 6,450	*3600 *7,900	2550 5,550	8360 330
1.5 m 5.0 ft	kg lb					*9350 *20,150	5950 12,800	6150 13,200	4000 8,600	4400 9,450	2900 6,200	3700 8,100	2400 5,300	8450 340
0.0 m 0.0 ft	kg lb			*6200 *14,200	*6200 *14,200	9150 19,650	5650 12,100	5900 12,750	3800 8,150	4300 9,250	2800 6,000	3750 8,250	2450 5,350	8260 330
-1.5 m -5.0 ft	kg lb	*6600 *14,750	*6600 *14,750	*10 700 *24,300	10 500 22,450	9050 19,400	5550 11,900	5850 12,550	3700 8,000	4250 9,150	2750 5,950	4050 8,950	2650 5,800	7780 310
-3.0 m -10.0 ft	kg lb	*11 350 *25,500	*11 350 *25,500	*13 700 *29,600	10 700 22,900	9100 19,550	5600 12,050	5850 12,600	3750 8,050			4800 10,650	3100 6,900	6950 280
-4.5 m -15.0 ft	kg lb			*10 850 *23,250	*10 850 *23,250	*7800 *16,600	5800 12,550					*5900 *12,900	4350 9,750	5600 220



ISO 10567



*Indicates that the load is limited by hydraulic lifting capacity rather than tipping load. The above loads are in compliance with hydraulic excavator lift capacity standard ISO 10567:2007. They do not exceed 87% of hydraulic lifting capacity or 75% of tipping load. Weight of all lifting accessories must be deducted from the above lifting capacities. Lifting capacities are based on the machine standing on a firm, uniform supporting surface. The use of a work tool attachment point to handle/lift objects, could affect the machine lift performance.









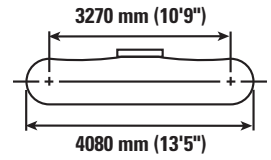
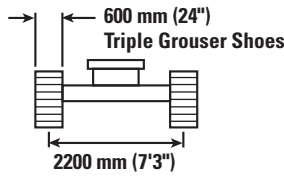
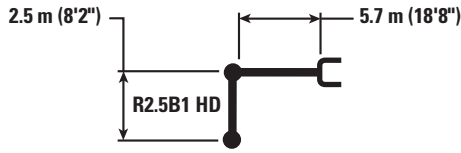

Lift capacity stays with ±5% for all available track shoes.

Always refer to the appropriate Operation and Maintenance Manual for specific product information.

320D2/D2 L Hydraulic Excavator Specifications

HD Reach Boom Lift Capacities – with Bucket Linkages, without Bucket – Standard Undercarriage



		3.0 m/10.0 ft		4.5 m/15.0 ft		6.0 m/20.0 ft		7.5 m/25.0 ft				mm in
												
7.5 m 25.0 ft	kg lb									*4700 *10,450	*4700 *10,450	5600 220
6.0 m 20.0 ft	kg lb					*5200 *11,450	4550 9,700			*4300 *9,500	3600 8,050	6830 270
4.5 m 15.0 ft	kg lb			*6600 *14,200	*6600 *14,200	*5650 *12,250	4400 9,400	4550	3050	*4200 *9,250	3000 6,600	7570 300
3.0 m 10.0 ft	kg lb			*8250 *17,750	6250 13,450	6250 13,450	4150 8,900	4450 9,500	2950 6,300	4050 8,900	2650 5,850	7960 320
1.5 m 5.0 ft	kg lb			9250 19,850	5750 12,400	6000 12,850	3900 8,350	4300 9,250	2850 6,050	3900 8,550	2550 5,600	8050 320
0.0 m 0.0 ft	kg lb			8950 19,250	5500 11,850	5800 12,500	3700 8,000	4250 9,100	2750 5,900	3950 8,700	2600 5,700	7860 310
-1.5 m -5.0 ft	kg lb	*11 300 *25,700	10 450 22,300	8900 19,150	5450 11,750	5750 12,350	3650 7,900			4350 9,600	2850 6,200	7350 290
-3.0 m -10.0 ft	kg lb	*12 800 *27,700	10 650 22,800	9050 19,400	5550 12,000	5850 12,550	3750 8,100			5300 11,700	3400 7,600	6470 260
-4.5 m -15.0 ft	kg lb			*6900 *14,400	5850 12,650					*5950 *13,050	5100 11,600	4980 200



ISO 10567



*Indicates that the load is limited by hydraulic lifting capacity rather than tipping load. The above loads are in compliance with hydraulic excavator lift capacity standard ISO 10567:2007. They do not exceed 87% of hydraulic lifting capacity or 75% of tipping load. Weight of all lifting accessories must be deducted from the above lifting capacities. Lifting capacities are based on the machine standing on a firm, uniform supporting surface. The use of a work tool attachment point to handle/lift objects, could affect the machine lift performance.









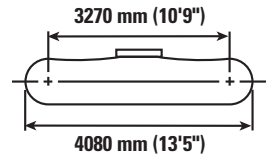
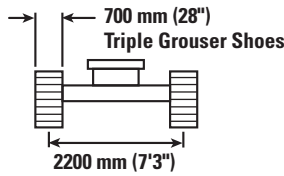
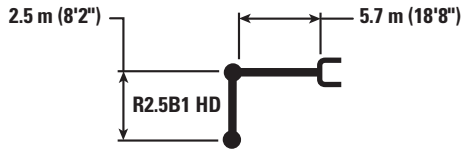

Lift capacity stays with ±5% for all available track shoes.

Always refer to the appropriate Operation and Maintenance Manual for specific product information.

320D2/D2 L Hydraulic Excavator Specifications

HD Reach Boom Lift Capacities – with Bucket Linkages, without Bucket – Standard Undercarriage



		3.0 m/10.0 ft		4.5 m/15.0 ft		6.0 m/20.0 ft		7.5 m/25.0 ft				mm in
												
7.5 m 25.0 ft	kg lb									*4700 *10,450	*4700 *10,450	5600 220
6.0 m 20.0 ft	kg lb					*5200 *11,450	4600 9,850			*4300 *9,500	3650 8,200	6830 270
4.5 m 15.0 ft	kg lb			*6600 *14,200	*6600 *14,200	*5650 *12,250	4450 9,550	4600	3100	*4200 *9,250	3050 6,700	7570 300
3.0 m 10.0 ft	kg lb			*8250 *17,750	6350 13,650	6350 13,650	4200 9,000	4500 9,650	3000 6,400	4100 9,050	2700 5,950	7960 320
1.5 m 5.0 ft	kg lb			9400 20,200	5850 12,600	6100 13,100	3950 8,500	4400 9,400	2900 6,200	3950 8,700	2600 5,700	8050 320
0.0 m 0.0 ft	kg lb			9100 19,550	5600 12,050	5900 12,700	3800 8,150	4300 9,250	2800 6,000	4050 8,900	2650 5,800	7860 310
-1.5 m -5.0 ft	kg lb	*11 300 *25,700	10 600 22,700	9050 19,450	5550 11,950	5850 12,600	3750 8,050			4400 9,750	2900 6,350	7350 290
-3.0 m -10.0 ft	kg lb	*12 800 *27,700	10 800 23,200	9200 19,700	5650 12,200	5950 12,800	3800 8,200			5350 11,900	3500 7,700	6470 260
-4.5 m -15.0 ft	kg lb			*6900 *14,400	5950 12,850					*5950 *13,050	5200 11,800	4980 200



ISO 10567



*Indicates that the load is limited by hydraulic lifting capacity rather than tipping load. The above loads are in compliance with hydraulic excavator lift capacity standard ISO 10567:2007. They do not exceed 87% of hydraulic lifting capacity or 75% of tipping load. Weight of all lifting accessories must be deducted from the above lifting capacities. Lifting capacities are based on the machine standing on a firm, uniform supporting surface. The use of a work tool attachment point to handle/lift objects, could affect the machine lift performance.

Lift capacity stays with ±5% for all available track shoes.

Always refer to the appropriate Operation and Maintenance Manual for specific product information.

320D2/D2 L Hydraulic Excavator Specifications

HD Reach Boom Lift Capacities – with Bucket Linkages, without Bucket – Long Undercarriage

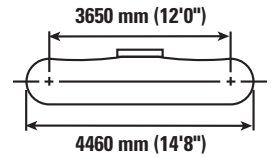
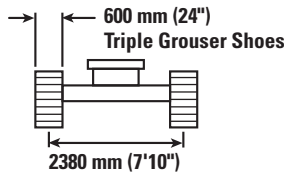
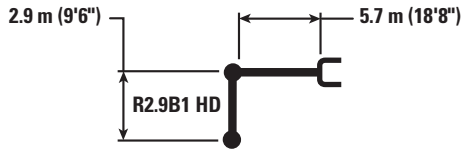

		1.5 m/5.0 ft		3.0 m/10.0 ft		4.5 m/15.0 ft		6.0 m/20.0 ft		7.5 m/25.0 ft		mm in		
7.5 m 25.0 ft	kg lb							*4500	*4500			*3850 *8,600	*3850 *8,600	6150 240
6.0 m 20.0 ft	kg lb							*4800 *10,550	*4800 *10,550			*3600 *7,900	*3600 *7,900	7290 290
4.5 m 15.0 ft	kg lb							*5300 *11,500	4900 10,600	*4950 *10,850	3400 7,300	*3500 *7,700	3050 6,750	7990 320
3.0 m 10.0 ft	kg lb					*7750 *16,650	7150 15,400	*6050 *13,150	4650 10,000	5250 11,300	3300 7,100	*3600 *7,900	2800 6,100	8360 330
1.5 m 5.0 ft	kg lb					*9350 *20,150	6600 14,200	*6900 *14,900	4400 9,450	5100 11,000	3200 6,850	*3800 *8,350	2650 5,850	8450 340
0.0 m 0.0 ft	kg lb			*6200 *14,200	*6200 *14,200	*10 250 *22,150	6250 13,500	6950 14,950	4200 9,050	5000 10,750	3100 6,650	*4200 *9,300	2700 5,950	8260 330
-1.5 m -5.0 ft	kg lb	*6600 *14,750	*6600 *14,750	*10 700 *24,300	*10 700 *24,300	*10 350 *22,350	6200 13,300	6850 14,750	4100 8,850	5000 10,700	3050 6,550	4750 10,450	2900 6,400	7780 310
-3.0 m -10.0 ft	kg lb	*11 350 *25,500	*11 350 *25,500	*13 700 *29,600	12 150 26,000	*9650 *20,850	6250 13,400	6900 14,850	4150 8,950			5600 12,450	3450 7,600	6950 280
-4.5 m -15.0 ft	kg lb			*10 850 *23,250	*10 850 *23,250	*7800 *16,600	6450 13,950					*5900 *12,900	4800 10,750	5600 220



ISO 10567



*Indicates that the load is limited by hydraulic lifting capacity rather than tipping load. The above loads are in compliance with hydraulic excavator lift capacity standard ISO 10567:2007. They do not exceed 87% of hydraulic lifting capacity or 75% of tipping load. Weight of all lifting accessories must be deducted from the above lifting capacities. Lifting capacities are based on the machine standing on a firm, uniform supporting surface. The use of a work tool attachment point to handle/lift objects, could affect the machine lift performance.

Lift capacity stays with ±5% for all available track shoes.

Always refer to the appropriate Operation and Maintenance Manual for specific product information.

320D2/D2 L Hydraulic Excavator Specifications

HD Reach Boom Lift Capacities – with Bucket Linkages, without Bucket – Long Undercarriage

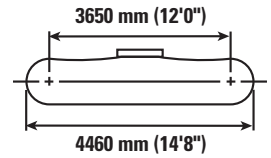
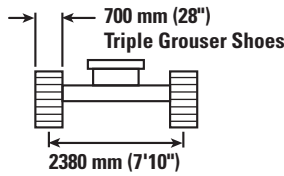
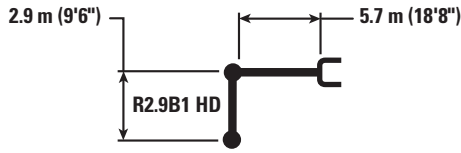

		1.5 m/5.0 ft		3.0 m/10.0 ft		4.5 m/15.0 ft		6.0 m/20.0 ft		7.5 m/25.0 ft		mm in		
7.5 m 25.0 ft	kg lb							*4500	*4500			*3850 *8,600	*3850 *8,600	6150 240
6.0 m 20.0 ft	kg lb							*4800 *10,550	*4800 *10,550			*3600 *7,900	*3600 *7,900	7290 290
4.5 m 15.0 ft	kg lb							*5300 *11,500	5000 10,750	*4950 *10,850	3500 7,450	*3500 *7,700	3100 6,900	7990 320
3.0 m 10.0 ft	kg lb					*7750 *16,650	7250 15,650	*6050 *13,150	4750 10,200	*5300 *11,500	3350 7,250	*3600 *7,900	2850 6,200	8360 330
1.5 m 5.0 ft	kg lb					*9350 *20,150	6700 14,450	*6900 *14,900	4450 9,600	5200 11,200	3250 6,950	*3800 *8,350	2700 5,950	8450 340
0.0 m 0.0 ft	kg lb			*6200 *14,200	*6200 *14,200	*10 250 *22,150	6400 13,750	7100 15,250	4300 9,200	5100 10,950	3150 6,750	*4200 *9,300	2750 6,050	8260 330
-1.5 m -5.0 ft	kg lb	*6600 *14,750	*6600 *14,750	*10 700 *24,300	*10 700 *24,300	*10 350 *22,350	6300 13,500	7000 15,050	4200 9,000	5050 10,900	3100 6,700	4850 10,650	2950 6,550	7780 310
-3.0 m -10.0 ft	kg lb	*11 350 *25,500	*11 350 *25,500	*13 700 *29,600	12 350 26,450	*9650 *20,850	6350 13,650	7050 15,150	4250 9,100			5700 12,650	3500 7,750	6950 280
-4.5 m -15.0 ft	kg lb			*10 850 *23,250	*10 850 *23,250	*7800 *16,600	6600 14,200					*5900 *12,900	4850 10,950	5600 220



ISO 10567



*Indicates that the load is limited by hydraulic lifting capacity rather than tipping load. The above loads are in compliance with hydraulic excavator lift capacity standard ISO 10567:2007. They do not exceed 87% of hydraulic lifting capacity or 75% of tipping load. Weight of all lifting accessories must be deducted from the above lifting capacities. Lifting capacities are based on the machine standing on a firm, uniform supporting surface. The use of a work tool attachment point to handle/lift objects, could affect the machine lift performance.









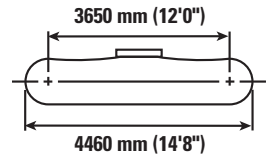
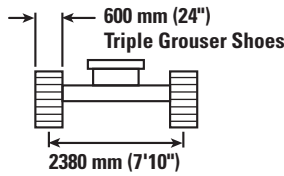
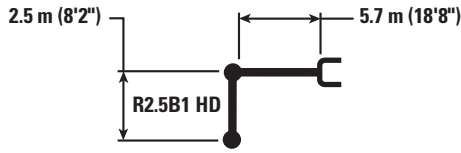

Lift capacity stays with ±5% for all available track shoes.

Always refer to the appropriate Operation and Maintenance Manual for specific product information.

320D2/D2 L Hydraulic Excavator Specifications

HD Reach Boom Lift Capacities – with Bucket Linkages, without Bucket – Long Undercarriage



		3.0 m/10.0 ft		4.5 m/15.0 ft		6.0 m/20.0 ft		7.5 m/25.0 ft				mm in
												
7.5 m 25.0 ft	kg lb									*4700 *10,450	*4700 *10,450	5600 220
6.0 m 20.0 ft	kg lb					*5200 *11,450	5000 10,750			*4300 *9,500	4000 8,950	6830 270
4.5 m 15.0 ft	kg lb			*6600 *14,200	*6600 *14,200	*5650 *12,250	4850 10,450	*4750	3350	*4200 *9,250	3300 7,350	7570 300
3.0 m 10.0 ft	kg lb			*8250 *17,750	7000 15,100	*6350 *13,800	4600 9,900	5250 11,200	3300 7,050	*4300 *9,500	3000 6,550	7960 320
1.5 m 5.0 ft	kg lb			*9750 *20,950	6500 13,950	*7100 15,350	4350 9,350	5100 10,950	3150 6,800	4600 10,100	2850 6,250	8050 320
0.0 m 0.0 ft	kg lb			*10 350 *22,450	6250 13,400	6950 14,950	4200 9,000	5000 10,800	3100 6,650	4700 10,350	2900 6,400	7860 310
-1.5 m -5.0 ft	kg lb	*11 300 *25,700	*11 300 *25,700	*10 200 *22,150	6200 13,300	6900 14,800	4150 8,900			5150 11,400	3200 7,000	7350 290
-3.0 m -10.0 ft	kg lb	*12 800 *27,700	12 300 26,300	*9300 *20,050	6300 13,550	*6850 *14,650	4200 9,100			*6100 *13,450	3850 8,500	6470 260
-4.5 m -15.0 ft	kg lb			*6900 *14,400	6600 14,250					*5950 *13,050	5750 13,000	4980 200



ISO 10567



*Indicates that the load is limited by hydraulic lifting capacity rather than tipping load. The above loads are in compliance with hydraulic excavator lift capacity standard ISO 10567:2007. They do not exceed 87% of hydraulic lifting capacity or 75% of tipping load. Weight of all lifting accessories must be deducted from the above lifting capacities. Lifting capacities are based on the machine standing on a firm, uniform supporting surface. The use of a work tool attachment point to handle/lift objects, could affect the machine lift performance.

Lift capacity stays with ±5% for all available track shoes.

Always refer to the appropriate Operation and Maintenance Manual for specific product information.

